

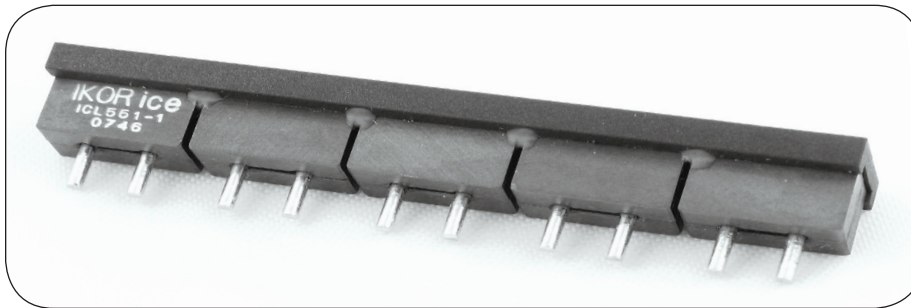

5-phase VRD/POL Inductor

ICL551-1



Applications

- VRDs (Imbedded)
- VRMs (Module)
- POLs
- VRM 10.x / VRM11 based designs
- DDR2/3 memory

Features

- Design for use with IKOR's proprietary coupled inductor multi-phase DC-DC converter topology
- Low height and small size allows use in both imbedded (VRD) and module (VRM) applications
- Integrated design lowers cost and simplifies assembly

The ICL551-1, a 5-phase inductor assembly using IKOR's coupled inductor technology, solves the most pressing problem facing IA-32 VRDs. This patented technology solves the trade-off between efficiency and elimination of bulk capacitors by dramatically lowering the VRM output inductance while using industry-standard components and relatively low switching frequencies. This technology provides superior transient response performance to higher frequency solutions due to the unique method of coupling between phases, and enables high-current designs with little or no electrolytic output bypass capacitance. The ICL551-1 5-phase coupled inductor assembly is designed for VRD applications. Its integrated design allows it to fit the inductors very close to the CPU socket in VRD applications. This device can also be used in high current System VRM (SVRM) applications where small size, high efficiency, and low total BOM cost is critical.

Single Inductor Electrical Specifications

Parameter	Test Conditions	Min	Typ	Max	Unit
L_s	1.0 Vrms @ 500 kHz	264	330	396	nH
LL	1.0 Vrms @ 500 kHz	45		53	nH

Inductor Assembly Electrical Specifications

Parameter	Test Conditions	Min	Typ	Max	Unit
L_s (1-3)	1.0 Vrms @ 500 kHz	528	660	792	nH
L_s (2-5)	1.0 Vrms @ 500 kHz	528	660	792	nH
L_s (4-7)	1.0 Vrms @ 500 kHz	528	660	792	nH
L_s (6-9)	1.0 Vrms @ 500 kHz	528	660	792	nH
L_s (8-10)	1.0 Vrms @ 500 kHz	528	660	792	nH
DCR (1-3)	25° C	.387	.43	.473	mΩ
DCR (2-5)	25° C	.477	.53	.583	mΩ
DCR (4-7)	25° C	.477	.53	.583	mΩ
DCR (6-9)	25° C	.477	.53	.583	mΩ
DCR (8-10)	25° C	.387	.43	.473	mΩ



5-phase VRD/POL Inductor ICL551-1

Inductor Assembly

units: mm

Front View

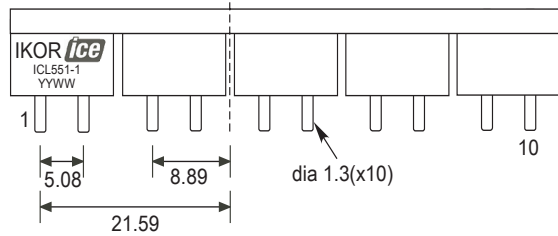

Top View

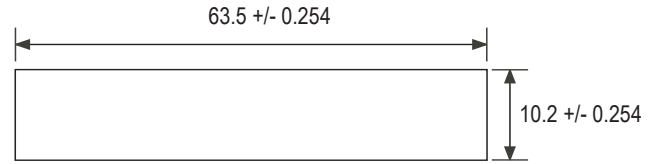

Side View

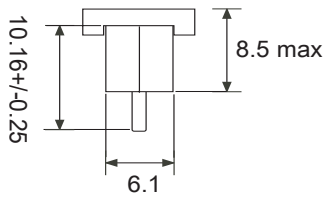

Schematic

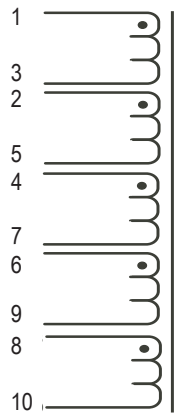

Layout

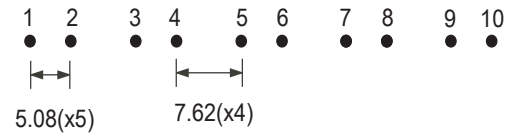

Single Inductor

units: mm

Application Schematic

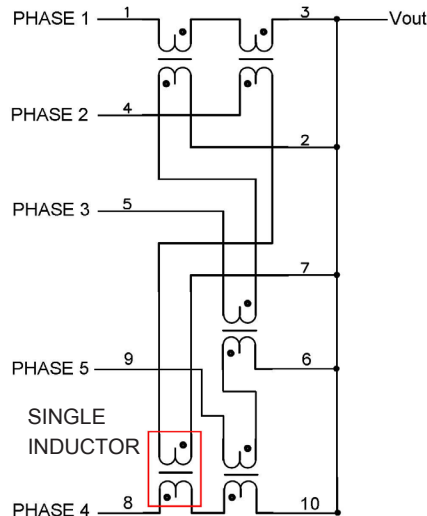

The technology utilized in conjunction with the coupled inductor ("the CL") described in this data sheet includes intellectual property (the "IP") owned by iWatt, Inc. and is covered by one or more of the following U.S. patents: 6,545,450; 6,686,727; 6,696,823. In connection with the end customer's purchase of the CL from "ICE Components, Inc.", the end customer is hereby granted a non-exclusive, worldwide, royalty-free license (without rights to sublicense) to use and incorporate the IP in the end customer's product that also incorporates the CL. In no way does this license extend to customer end products which do not incorporate the CL to implement the IP.